

A 20 MS

EDIT 180620

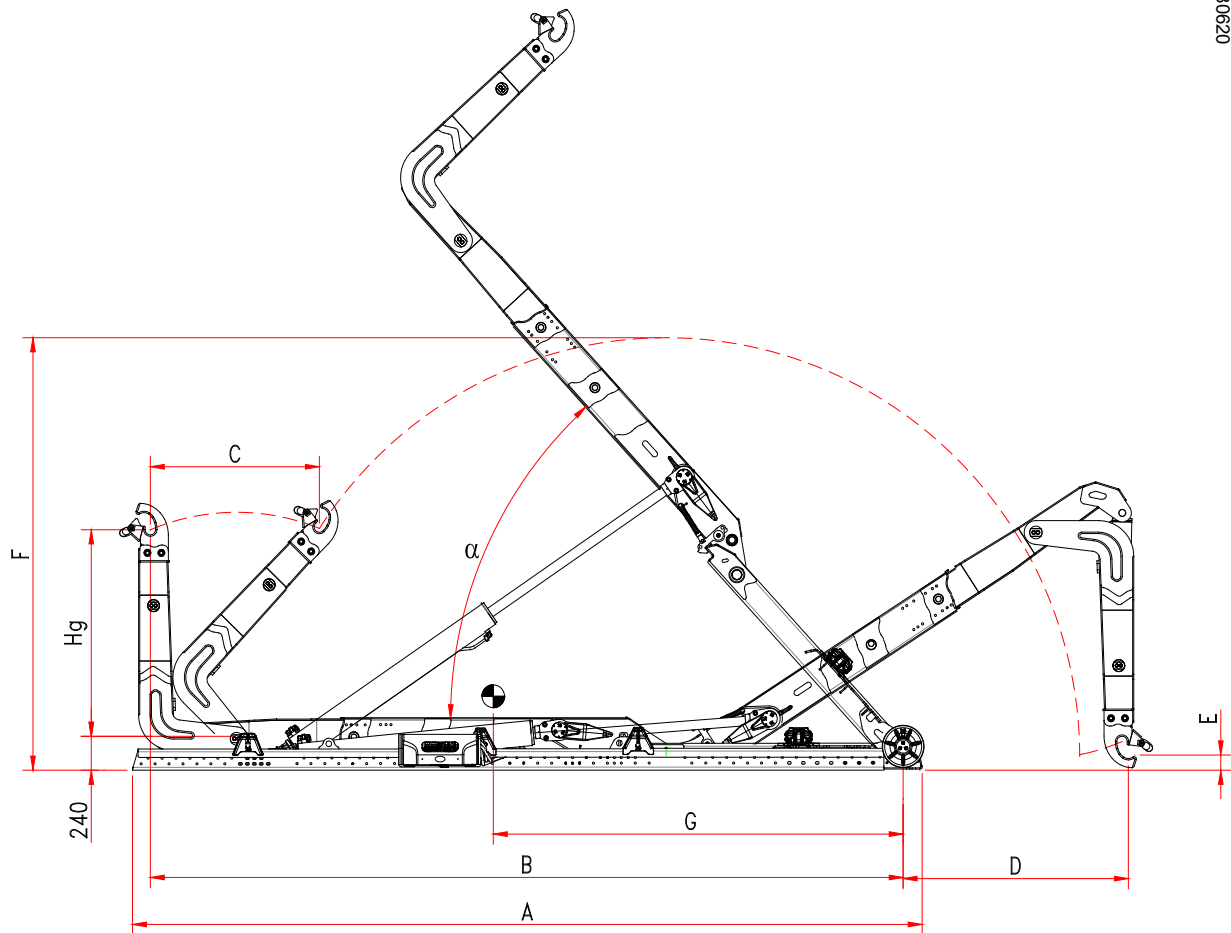

Model	Hg	A	B	C	D	E	F	G	Weight	α	Container	
											min.	max.
A 20 C MS	1.425/1.570	5.280	4.800	1.200	1.850	0	2.900	2.620	2.000 kg	55°	4.200	5.400
A 20 NC MS	1.425/1.570	5.280	5.000	1.200	1.650	0	2.900	2.760	2.030 kg	51°	4.200	5.600
A 20 N MS	1.425/1.570	5.480	5.200	1.200	1.450	0	2.900	2.900	2.060 kg	48°	4.400	5.800
A 20 NL MS	1.425/1.570	5.680	5.400	1.200	1.620	100	3.060	2.940	2.090 kg	48°	4.600	6.000
A 20 L MS	1.425/1.570	5.880	5.600	1.200	1.420	100	3.060	3.070	2.120 kg	45°	4.800	6.200